

Ax5

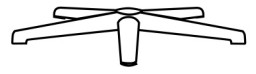

Bx1



Ax1

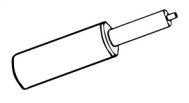

Dx1

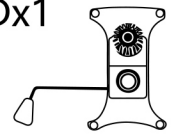

Ex4



M6x20

Fx8



M6x25

Gx2



Hx1



Ix1



Jx8

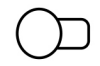

Kx1



GC-6048

ZOLDER

ASSEMBLE INSTRUCTIONS

Step1

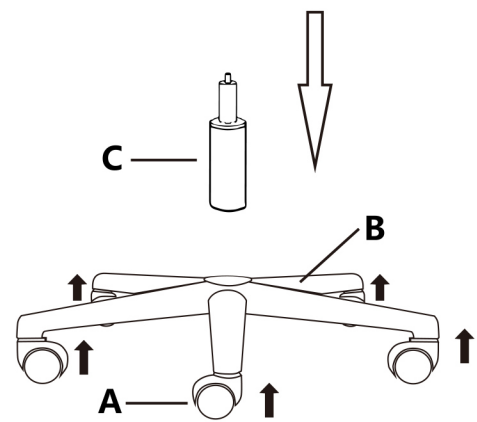

Step2

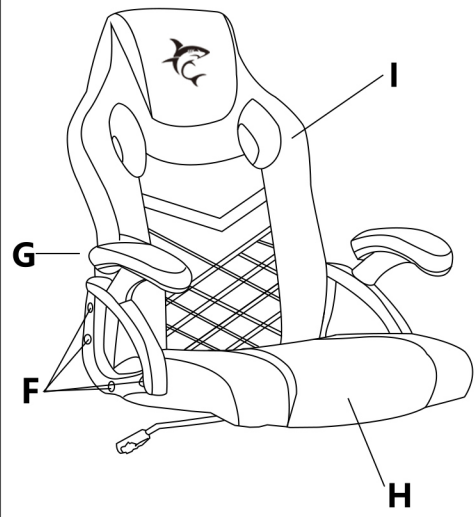

Step3

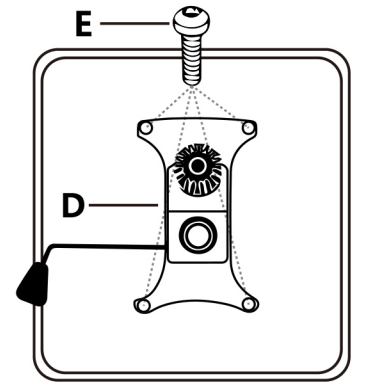

Step4

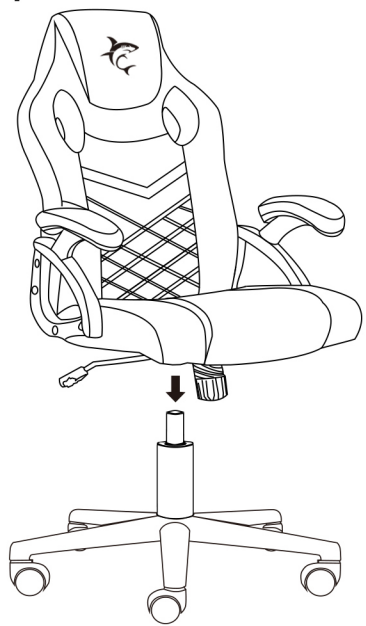

Step5

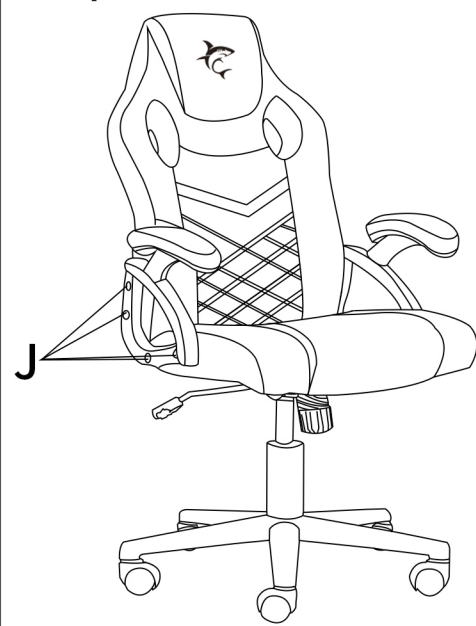

Step6

