

Button and interface description

- ① High toughness headband
- ② Eco-Leather + textile headband
- ③ Microphone switch
- ④ Volume adjustment dial
- ⑤ 3.5mm plug
- ⑥ Microphone transmitter

Product Application

1. Computer/NoteBook

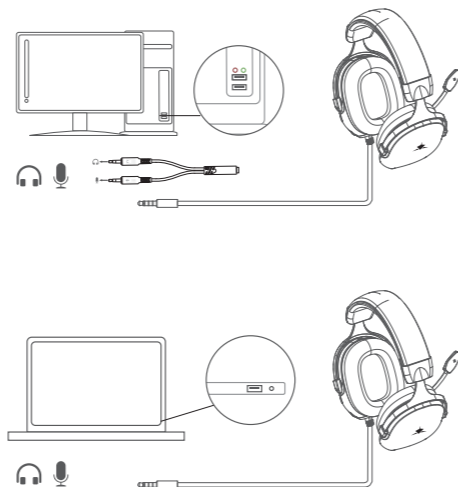

2. Xbox ONE

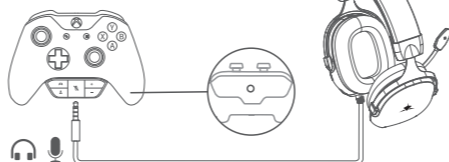

3. PS4/PS5

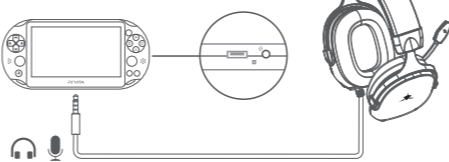
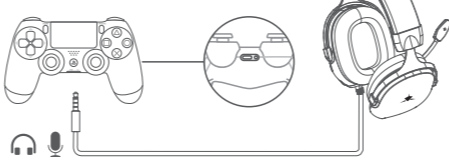

4. Nintendo Switch

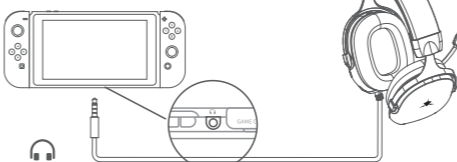

Note: Nintendo Switch does not support microphone

5. Mobile devices

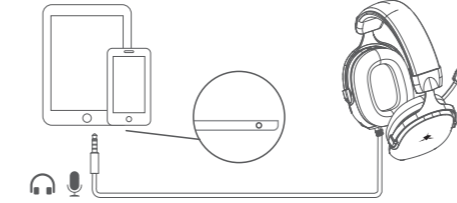

User Manual

- (1) Do not attempt to disassemble or replace any parts of the product except for the operations specified in the manual.
- (2) Do not place the product in water or any other liquid. This product is not waterproof.
- (3) If any liquid accidentally enters the product, immediately disconnect and remove the product.
- (4) To avoid electric shock, make sure your hands are not wet when installing or uninstalling the product.
- (5) Do not place this product near a heat source or expose it directly to a fire source.
- (6) Do not place this product in an environment with strong electromagnetic force, otherwise it may cause product failure.

Product Operation Instructions

1. Volume Adjustment
Increase volume: Rotate the pulley upwards according to the mark on the headset to increase the volume
Decrease volume: Rotate the pulley downwards according to the mark on the headset to decrease the volume
2. Microphone switch
Turn the microphone on or off by toggling the switch
3. Compatibility
Supports multiple platforms, including PC, NoteBook, PS4, PS5, Xbox ONE, Switch, Ipad, MobilPhone

Product Specifications

Speaker: NdFeB
Sensitivity: 106±3dB
Size: 50mm
Rated power: 20mW
Dynamic impedance: 32Ω±15%
Maximum power: 30mW
Frequency response: 20~20KHz

Microphone model: Electret condenser microphone
Sensitivity: -38±3dB
Size: Φ6.0*5.0
SNR: 58dB
Directivity: Omnidirectional
Output impedance: ≤2.2KΩ
Voltage operating range: 2V

Package List

Headset x 1
Manual x 1
adapter cable x 1

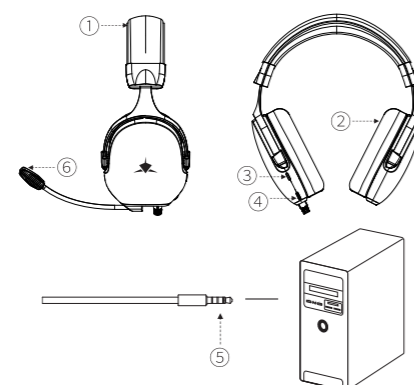

Opis gumba i sučelja

- ① Traka za glavu visoke čvrstoće
- ② Jastučići od eko kože s tekstilom
- ③ Prekidač mikrofona
- ④ Regulator za podešavanje glasnoće
- ⑤ 3.5mm priključak
- ⑥ Mikrofon

Primjena proizvoda

1. Računalo / Laptop

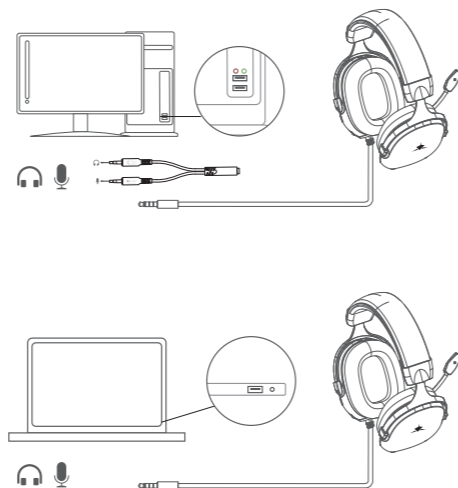

2. Xbox ONE

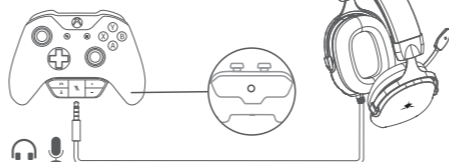

3. PS4/PS5

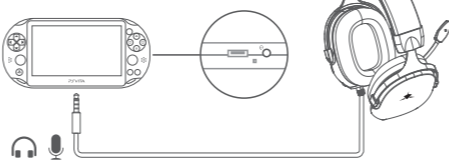
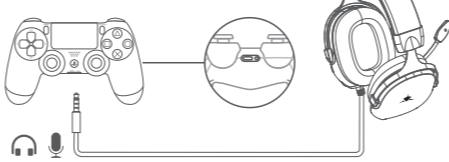

4. Nintendo Switch

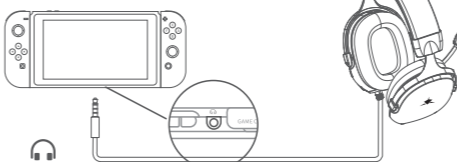

Napomena: Nintendo Switch ne podržava mikrofon

5. Mobilni uređaji

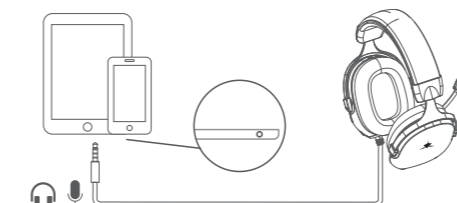

Korisnički priručnik

- (1) Nemojte pokušavati rastavljati ili zamjenjivati bilo koji dio proizvoda osim radnji navedenih u priručniku.
- (2) Nemojte stavljati proizvod u vodu ili bilo koju drugu tekućinu. Ovaj proizvod nije vodootporan.
- (3) Ako tekućina slučajno dospije u proizvod, odmah ga isključite i uklonite.
- (4) Kako biste izbjegli strujni udar, osigurajte da vam ruke nisu mokre prilikom instalacije ili uklanjanja proizvoda.
- (5) Nemojte postavljati ovaj proizvod blizu izvora topline niti ga izlagati izravnom plamenu.
- (6) Nemojte postavljati proizvod u okruženje s jakim elektromagnetskim silama, jer to može uzrokovati kvar proizvoda.

Upute za upotrebu

1. Podešavanje glasnoće
Povećanje glasnoće: Zakrenite kotačić prema gore prema oznaci na slušalicama.
Smanjenje glasnoće: Zakrenite kotačić prema dolje prema oznaci na slušalicama.
2. Prekidač mikrofona
Uključite ili isključite mikrofon pomoću prekidača.
3. Kompatibilnost
Podržava više platformi, uključujući PC, prijenosno računalo, PS4, PS5, Xbox ONE, Switch, iPad ili mobilni telefon.

Specifikacija proizvoda

Zvučnik: NdFeB
Osjetljivost: 106±3dB
Veličina: 50mm
Nazivna snaga: 20mW
Dinamična impedancija: 32±15%
Maksimalna snaga: 30mW
Raspon frekvencije: 20~20KHz

Model mikrofona: Elektretni kondenzatorski mikrofon
Osjetljivost: -38±3dB
Veličina: Φ6.0*5.0
SNR: 58dB
Usmjerenost: Omnidirekcijski
Izlazna impedancija: ≤2.2KΩ
Radni raspon napona: 2V

Sadržaj pakiranja

Slušalice x 1
Upute x 1
Adapter x 1

